

JUICE ATTITUDE

FORD JUICE **INSTALLATION INSTRUCTIONS**

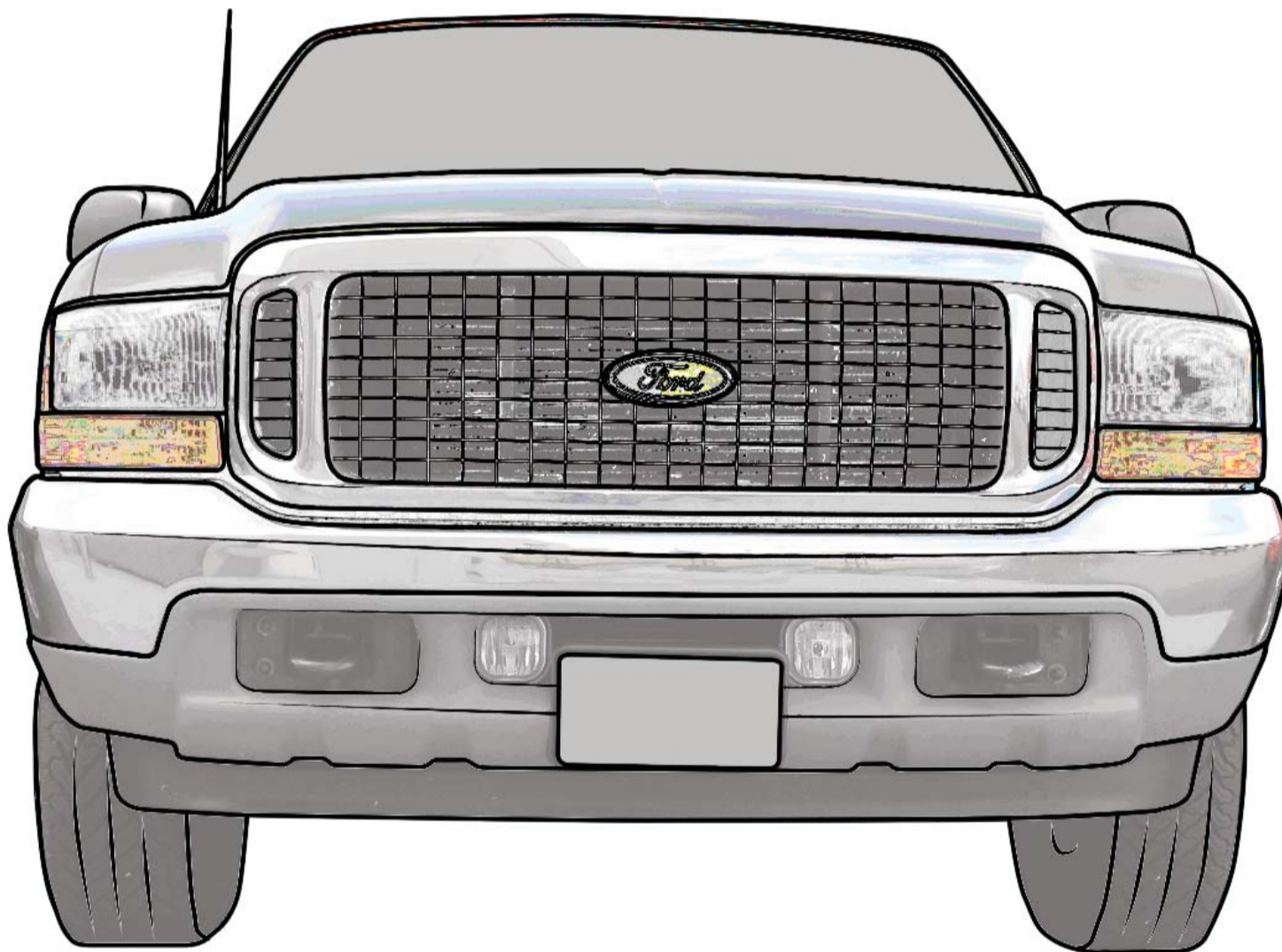

****READ IMPORTANT SAFETY INFORMATION IN THIS MANUAL****

EDGE
PRODUCTS

TABLE OF CONTENTS

ABOUT THE JUICE..... 3
 SAFETY TERMS..... 3

INTRODUCTION 3
 PRODUCT REGISTRATION..... 4
 IMPORTANT NOTES..... 5
 TRUCK ORIENTATION 6

INSTALLATION 7
 1999 - 2003 (7.3L) 7
 BATTERY DISCONNECT 8
 MAP SENSOR CONNECTION 8
 MAT SENSOR CONNECTION..... 9
 ICP SENSOR CONNECTION..... 9
 CMP SENSOR CONNECTION 10
 TPS SENSOR CONNECTION 11
 2003-2007 (6.0L) 12
 BATTERY REMOVAL..... 14
 PCM CONNECTIONS 14
 MAP SENSOR CONNECTION 15
 EGT PROBE INSTALLATION..... 17
 TAPPING AND PROBE INSTALLATION..... 17
 CONNECTING THE PROBE TO JUICE 19
 JAB INSTALLATION..... 20
 1999 TO 2007 - JAB INSTALLATION 20
 JUICE MODULE INSTALLATION 22
 FINAL JUICE MODULE INSTALLATION 22
 MOUNTING AND SECURING THE JUICE 22
 FINAL INSPECTION 23

OPERATING INSTRUCTIONS 24
 USING THE JUICE 24
 OPERATING THE ATTITUDE MODULE 24
 ADDITIONAL JUICE/ATTITUDE INFORMATION 24

APPENDIX..... 25
 ENGINE COMPARTMENT (REFERENCE)..... 25
 1999-2003..... 25
 2003-2007 26

TABLE OF CONTENTS

INTRODUCTION

INSTALLATION

OPERATING INSTRUCTIONS

APPENDIX

ABOUT THE JUICE

Congratulations on purchasing the Edge Juice/Attitude system for the Ford Power Stroke Diesel®.

The Juice/Attitude system features an intelligent module (Juice) that acts as an add-on Engine Control Module (ECM) for the Power Stroke® Engine. This module is controlled and customized in the cab of your truck by the Attitude monitor/controller.

This system offers many cutting-edge, additional features not available with the factory setup. Since the Juice Module is an add-on ECM, it uses data from your truck's computer or engine control module (ECM), and then enhances the factory settings to optimize your truck's performance. This product offers a wide variety of amazing performance and safety features that can ensure you get the driving experience you desire without damaging your valuable truck.

Please take the time to thoroughly review all of the features and product options outlined in this manual. Taking the time to understand how this product works and how to properly operate this product will ensure that you have an extraordinary and safe driving experience. If we can be of any assistance to help you get the most from your product please call us at 888-360-3343. We are open Monday through Friday from 8am to 5pm Mountain Time.

IMPORTANT: Read through these instructions completely so that you understand each step prior to installation. Refer to CS/CTS User Manual for Safety and Warranty information

SAFETY TERMS

Throughout this User Guide (hereafter noted as User Manual or Manual) you will see important messages regarding your safety or the protection of your vehicle. These messages are designated by the words WARNING or CAUTION.



WARNING indicates a condition that may cause serious injury or death to you, your passengers or others nearby. Pay careful attention to these Warning messages, and always comply with them. They could save a life.

CAUTION indicates a condition that could cause damage to your vehicle. It is important to install and operate your EDGE product in conformance with instructions in this Manual. Caution alerts you to particularly important things that will keep your vehicle operating properly.

PRODUCT REGISTRATION

PLEASE take the time to register your product on line at [edge-products.com](http://www.edge-products.com). Follow the instructions at link: http://www.edge-products.com/product_registration.php

BENEFITS OF PRODUCT REGISTRATION

- Your Safety** - Registering your product allows us to know exactly which product you have and provide important product updates to you that improve the quality and/or safety of the product.
- Enhanced Features** - Almost all Edge products are easily updated via the internet. We are constantly adding new features and improvements to our product that we know you will want to enjoy.
- Confirmation of Ownership** - Provides a record in case of product loss, theft, or required warranty work. When you call us for support our team will already have much of the information they need to help you.
- Improved Product Development** - Helps us better understand you (our customer) and design products that meet your needs.
- Special Offers** - Allows us to inform you about special offers on accessories and/or new products that fit your vehicle and enhance your driving experience.

IMPORTANT NOTES

1. If you have used another tuner/programmer on your truck, you will need to program your truck back to stock before using the Attitude or Juice.

Failure to return to stock may result in PCM failure or engine damage.

2. Programming your vehicle may expose existing defects in your vehicle's PCM that could disable your vehicle. It is advised that you do not program your vehicle in remote location in case of vehicle failure.

3. All Edge modules and programmers are built to operate with OEM calibrations. When you take your vehicle to a service center they may, by your request or otherwise, update your vehicle's calibrations. Therefore it is important that you return your vehicle to stock before taking it in for service. Edge updates its active products (i.e. those currently being manufactured) to work effectively with updated OEM calibrations. However, this process can take some time as Edge is not always made aware of calibration changes made by the OEM. In the case of discontinued products, Edge cannot ensure that your unit will work effectively if you take your vehicle to a dealership and you are given, by your request or otherwise, a new calibration.

4. For specific information regarding horsepower, torque, and other features available for this product:

- (1) Go to www.edgeproducts.com
- (2) Type the part number of your product in the "KEYWORD/PART# SEARCH" and press enter.
- (3) Click the link under "Description"
- (4) Scroll down to the "DOWNLOAD VEHICLE SPECIFIC HORSEPOWER, TORQUE, AND FEATURES CHART" link and click on it.
- (5) Find the information that is specific to your make and model.

NOTE: This product will not work on E-Series Vans, as some of the connectors are different from the F-Series pickups for which this product was designed for.

TRUCK ORIENTATION

ORIENTATION

The following view is a top view of the vehicle (looking down from above the vehicle). References in the text to “looking down”, means looking toward the ground. Looking up, means looking towards the sky from below the vehicle. Front, rear, left and right are as noted below. See Figure below.

Front of Truck

Driver side of truck—
Usually referred to
as the left side.

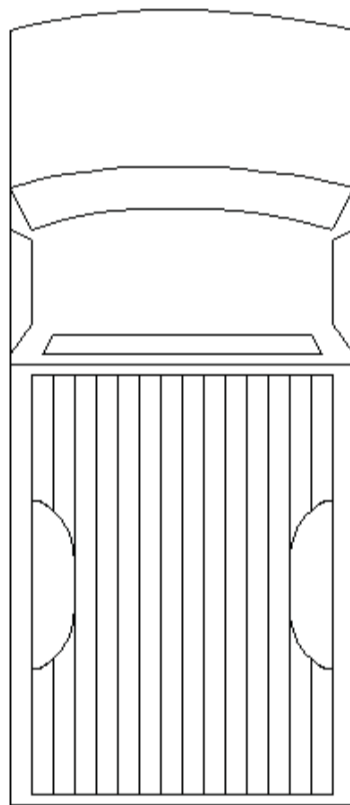

Passenger side of truck –
Usually referred to as the
right side.

Back of Truck





1999 - 2003 (7.3L)

Supplied Items

- ① Main Harness
- ② Juice Module
- ③ Throttle Position Sensor (TPS)
Harness - Year Specific
- ④ Velcro Strips
- ⑤ Zip Ties
- ⑥ EGT Sensor Probe
- ⑦ Juice Attitude Bridge (JAB)
- ⑧ CS/CTS Installation Guide

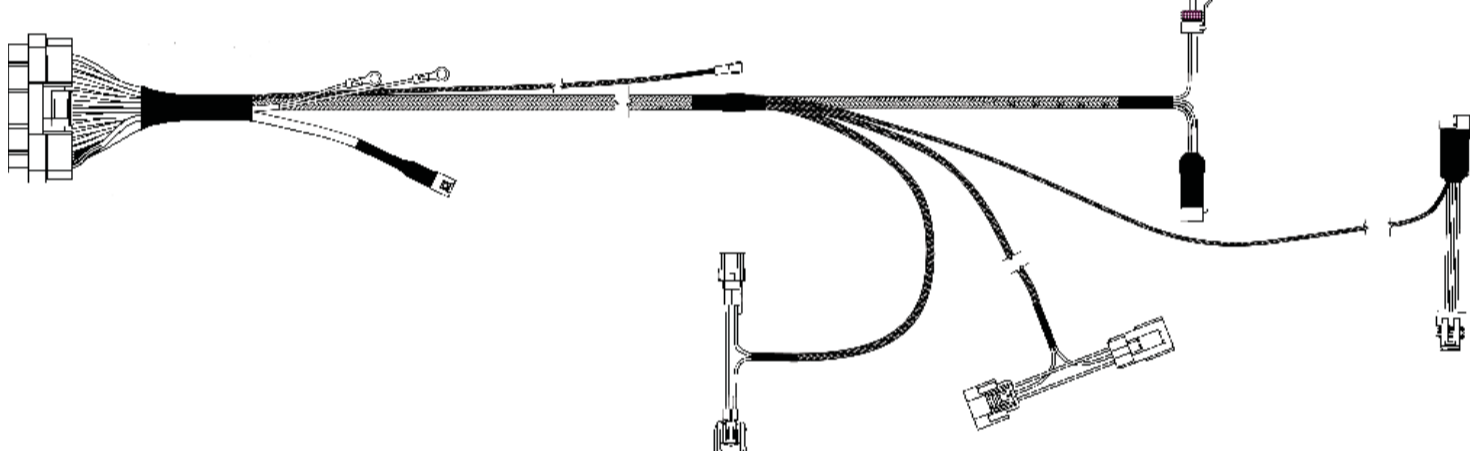
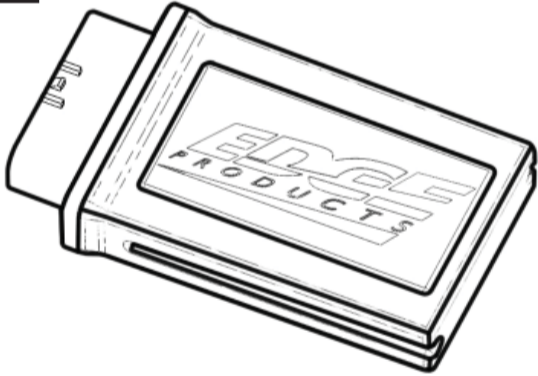
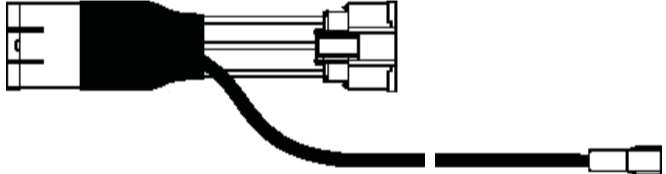
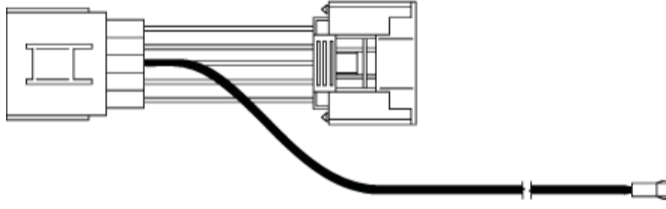
Required Tools

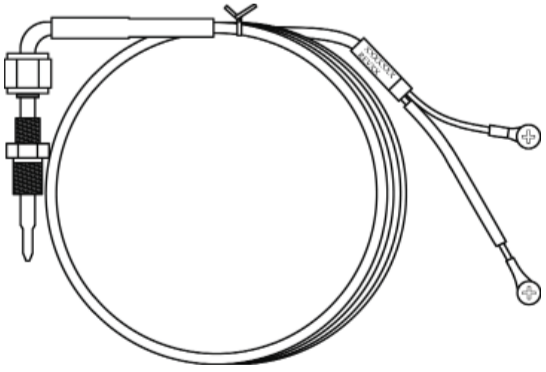
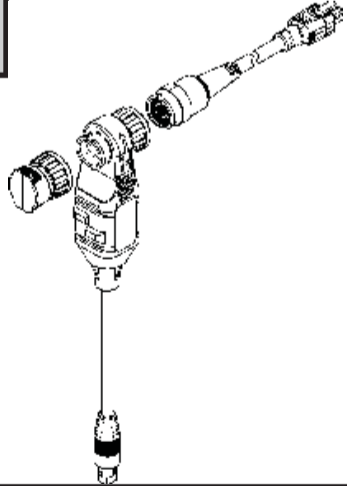
- Electric/Cordless Drill
- 1/8" drill bit or similar size (for pilot hole)
- 21/64" (best size) or 5/16" drill bit (for final hole)
- 9/16" wrench or socket
- 5/8" open end wrench
- 1/8"-27 NPT Thread Tap
- Phillips screwdriver
- 5/16" or 8mm wrench
- 13mm wrench

<p>1</p> 		
<p>2</p> 	<p>3</p> <p>99-00</p> 	<p>01-03</p> 
<p>4</p> 	<p>6</p> 	<p>7</p> 
<p>5</p> 	<p>8</p> <div style="border: 1px solid black; padding: 5px; width: fit-content; margin: 0 auto;"> <p>REFER TO QUICK INSTALL GUIDE FOR INSTALL</p> </div> <p><i>Note: Depending on your year of truck, you may not need everything provided.</i></p>	

Harness Connection Guide

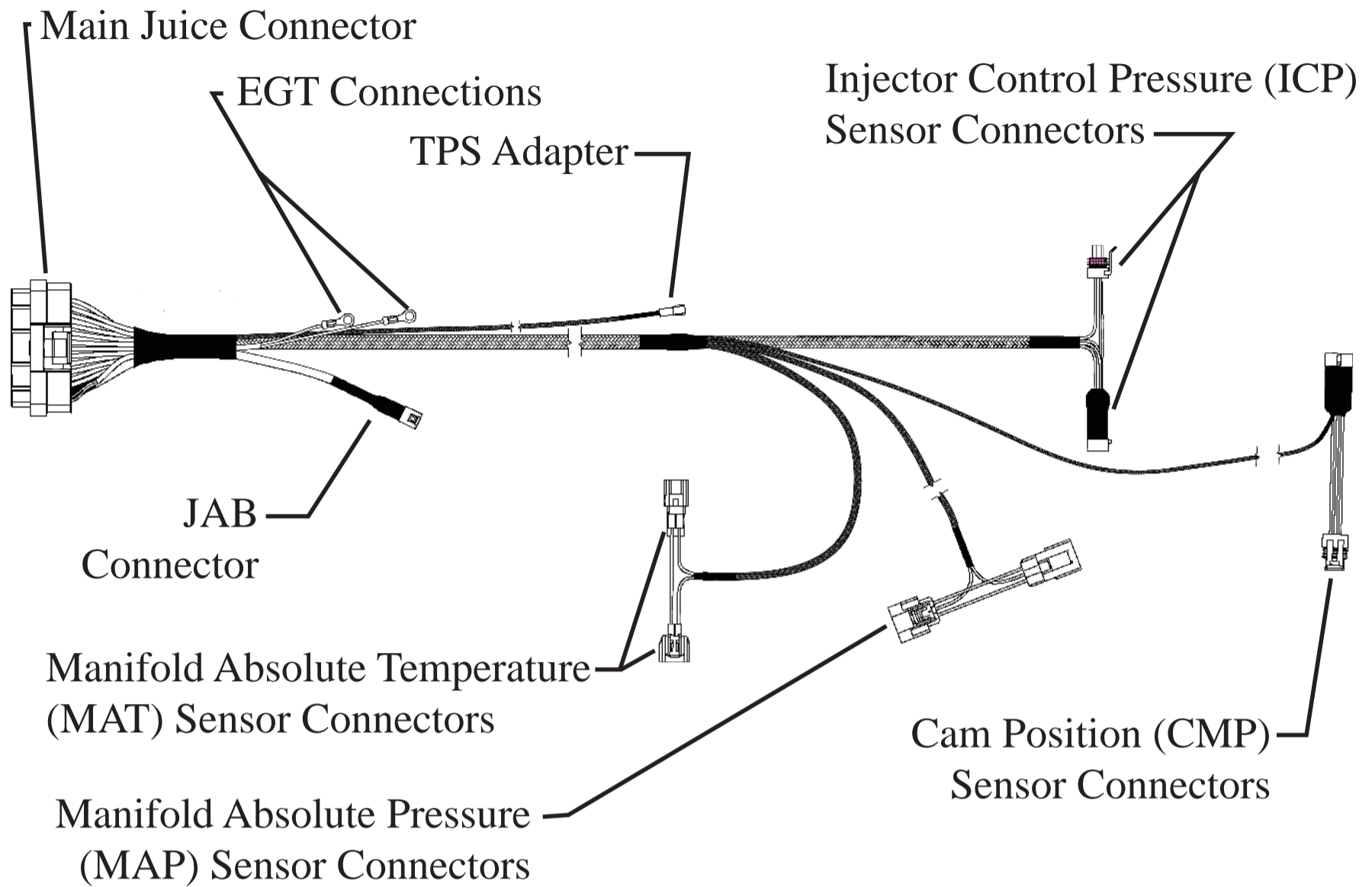

FIGURE 1

Juice Harness Installation Instructions

BATTERY DISCONNECT



WARNING *An electrical charge or battery acid can burn you. Battery gas can explode or ignite. Take care when working around the battery. Follow instructions in the vehicle owner's manual for disconnecting and reconnecting a battery.*

CAUTION: *It is strongly recommended for this installation that both batteries be disconnected.*

1. Use a 13 mm or 8 mm wrench to remove the NEGA-

TIVE terminal on each battery. (The wrench size depends on the battery style.)

2. Set the NEGATIVE terminal aside and secure it so it does not make contact with the battery during the installation.

MAP SENSOR CONNECTION

1. Connect the MAP connectors in between the stock harness and the sensor. See Figure 2.

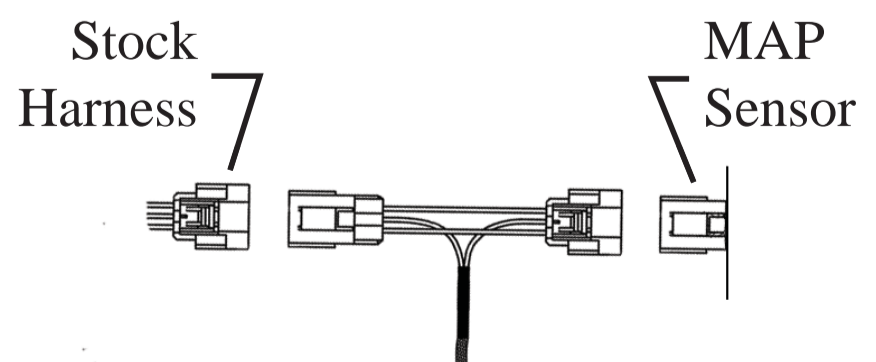

FIGURE 2 - "T" ASSEMBLY

TABLE OF CONTENTS

INTRODUCTION

INSTALLATION

OPERATING INSTRUCTIONS

APPENDIX

NOTE: This connection is located in front of the passenger side of the engine compartment (See Engine Compartment section of this manual).

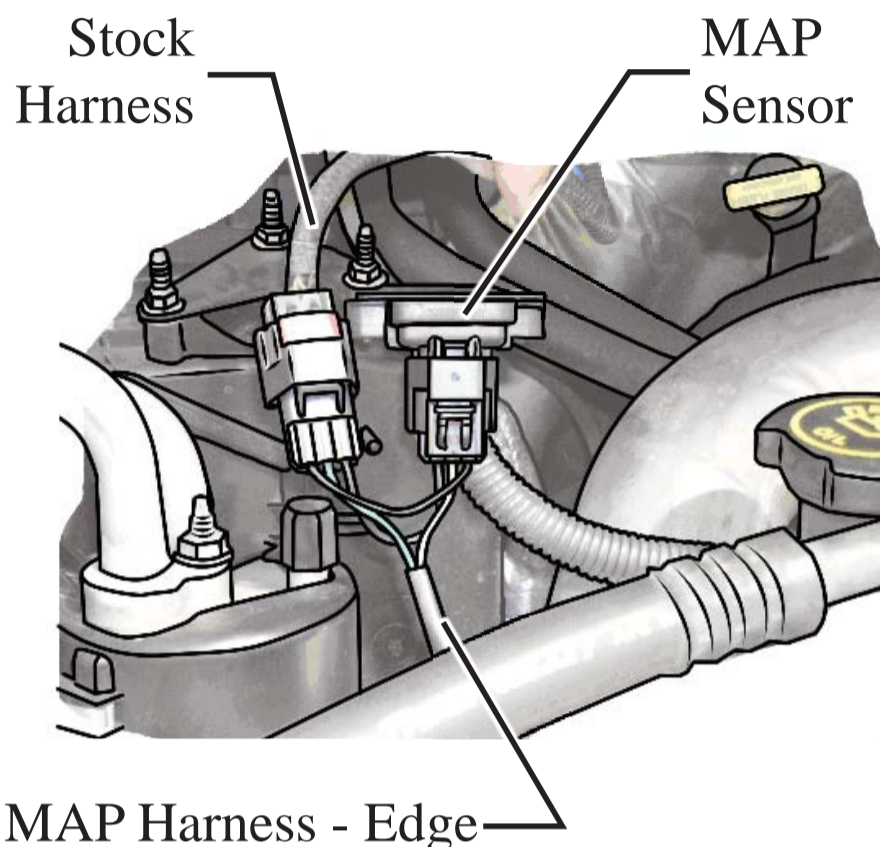

FIGURE 3 - ASSEMBLED VIEW

MAT SENSOR CONNECTION

1. Connect the MAT connectors in between the stock harness and the sensor as shown in Figure 4.

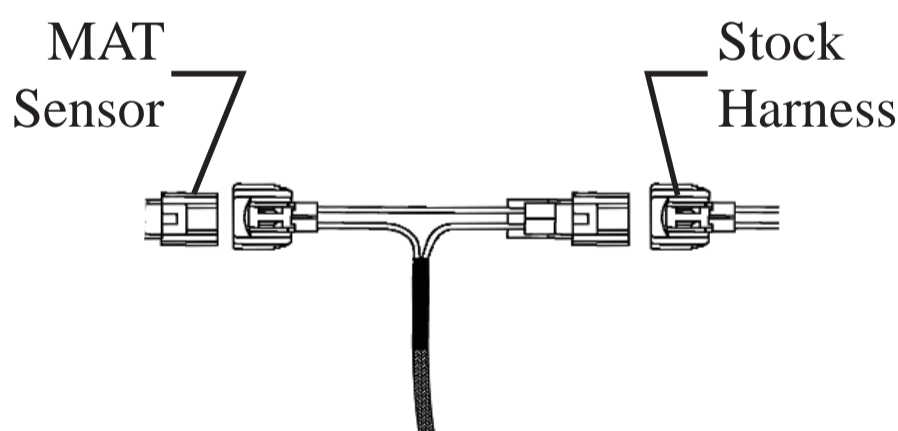

FIGURE 4 - "T" ASSEMBLY

NOTE: This connection is located in the middle of the of the engine compartment, and under the waste gate control solenoid (See Engine Compartment section of this manual).

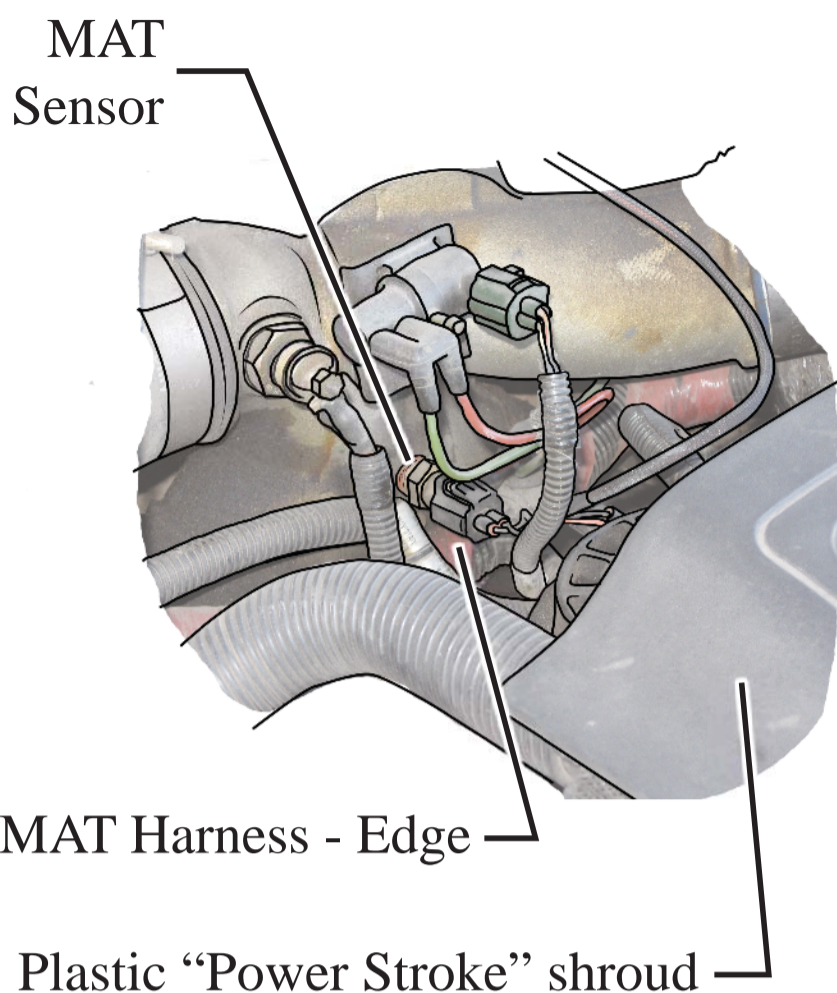

FIGURE 5 - ASSEMBLED VIEW

ICP SENSOR CONNECTION

1. Connect the ICP connectors in between the stock harness and the sensor. See Figure 6.

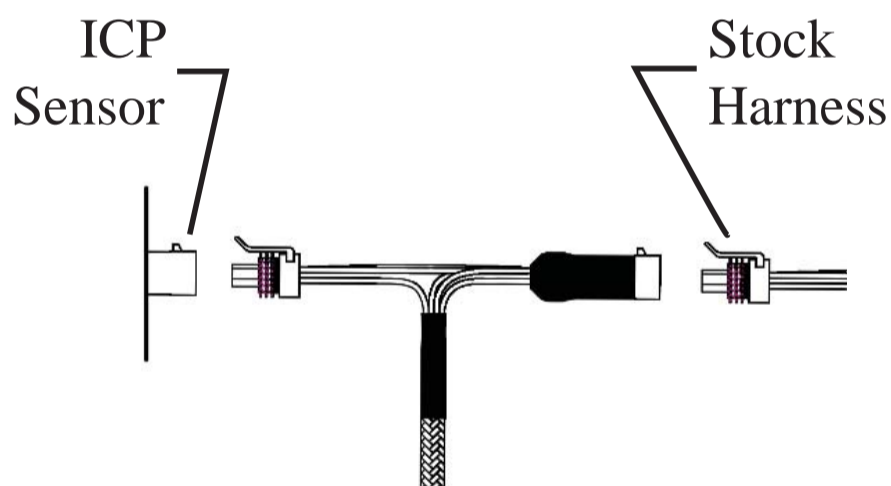

FIGURE 6 - "T" ASSEMBLY

NOTE: This connection is located in the middle of the engine compartment, and to the right of the MAT sensor (Towards driver side).

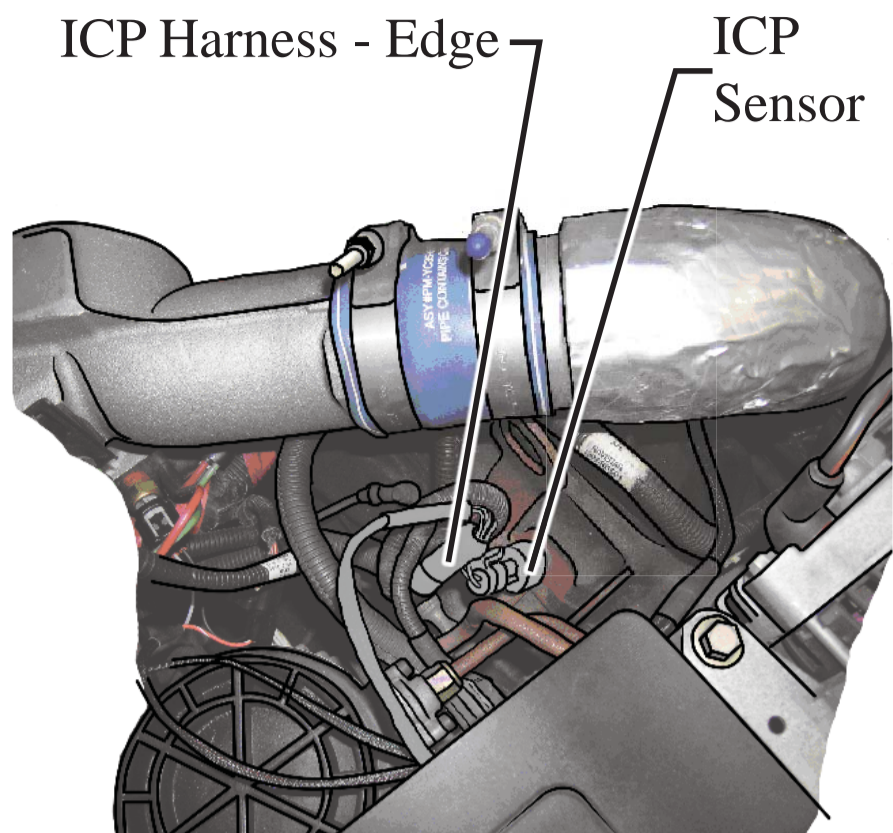

FIGURE 7 - ASSEMBLED VIEW

CAUTION: *The ICP sensor closely resembles the coolant sensor which is located towards the front of the engine. Figure 7 shows the proper location for the ICP Sensor.*

CMP SENSOR CONNECTION

The preferred method for routing the CMP harness is:

1. Remove the plastic “Power Stroke” cover located on top of the engine.
2. Route the CMP harness across the top of the engine, and down towards the bottom of the engine as shown in Figure 8. (It is best to route along side the factory wiring harness)

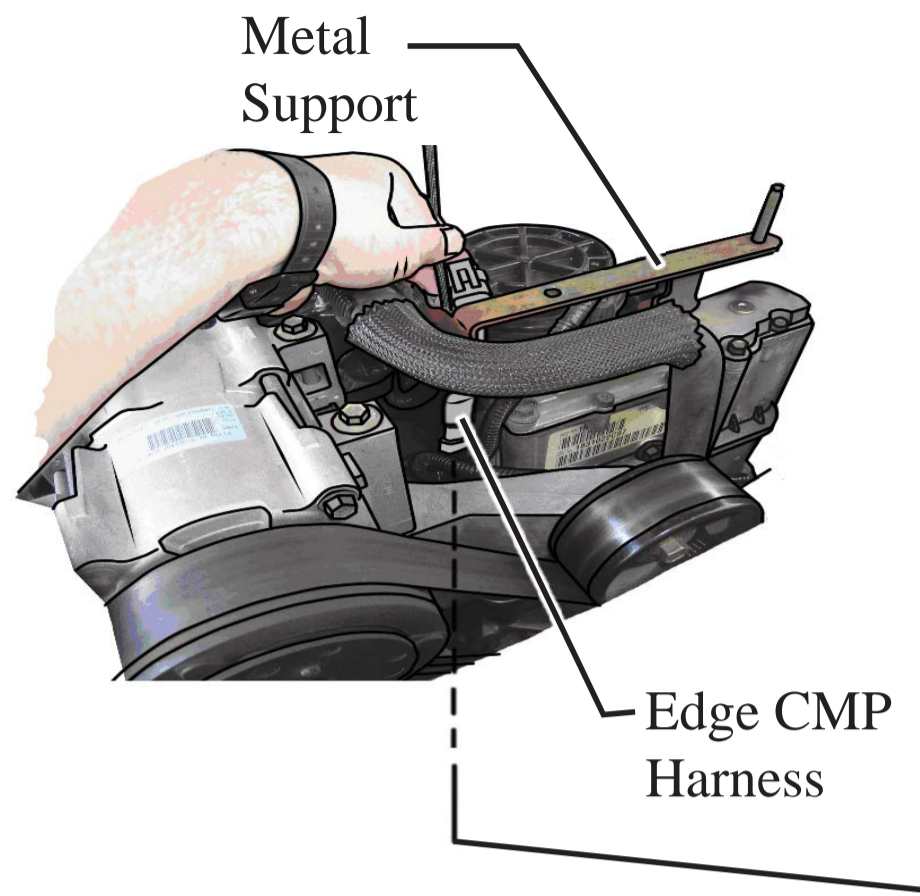

FIGURE 8 - ROUTING VIEW

3. Refer to Figure 10. The CMP sensor is located on the front of the engine. Looking “up” from underneath the truck, it will be above and towards the passenger side of the main pulley.

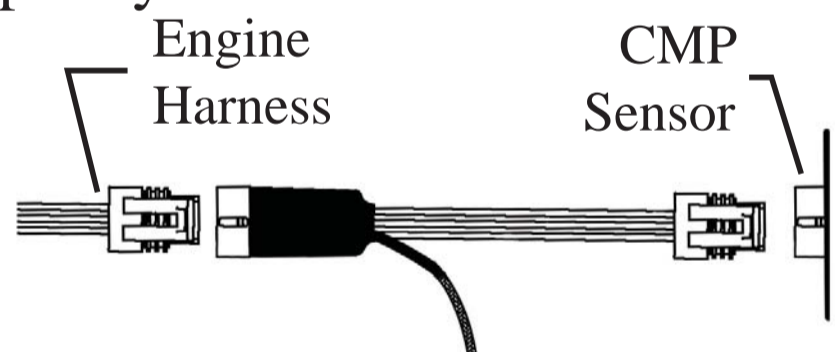
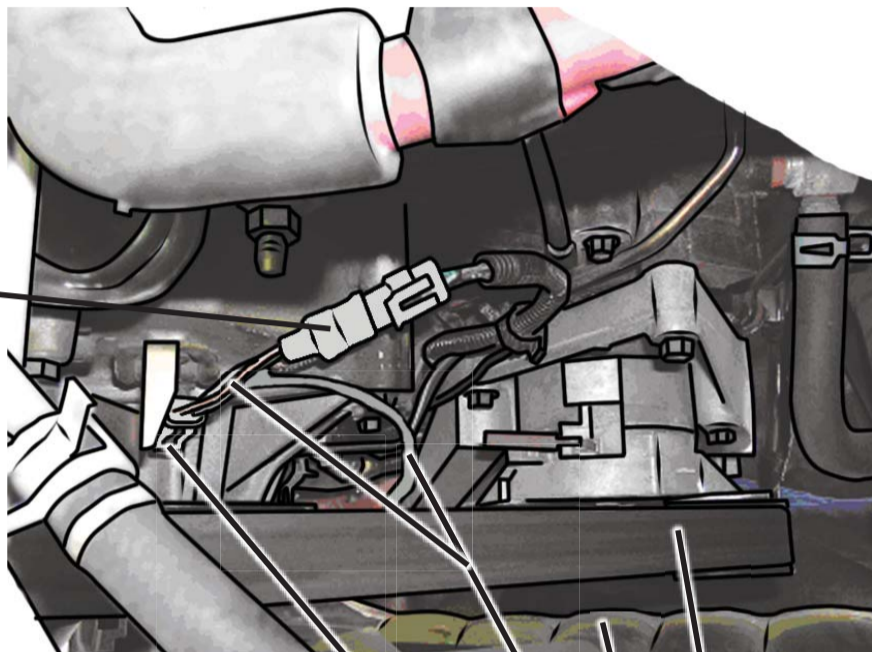

FIGURE 9 - “T” ASSEMBLY

4. Once the CMP sensor is located, and the Edge harness plugged in, use zip ties to keep all parts of the harness away from the belt or other moving parts.

(NOTE: *Fasten the Edge harness to the existing truck*

harness to ensure the best routing path is taken. The metal support for the plastic cover is a convenient place to secure the harness using a wire tie (see Figure 8).



CMP Sensor
Routed Edge Harness
Coolant Reservoir
Serpentine Belt

FIGURE 10 - ASSEMBLED VIEW (LOOKING “UP” FROM UNDERNEATH THE TRUCK)

TPS SENSOR CONNECTION

1. Using the information on page 7, locate the TPS Sensor harness that is specific to your truck.
2. Locate the truck’s Throttle Position Sensor (TPS) according to Figures 11 and 12.



Brake Linkage
TPS Sensor
Accelerator Linkage
Truck Harness
TPS Adapter - Edge

FIGURE 11 - 1999 to 2000

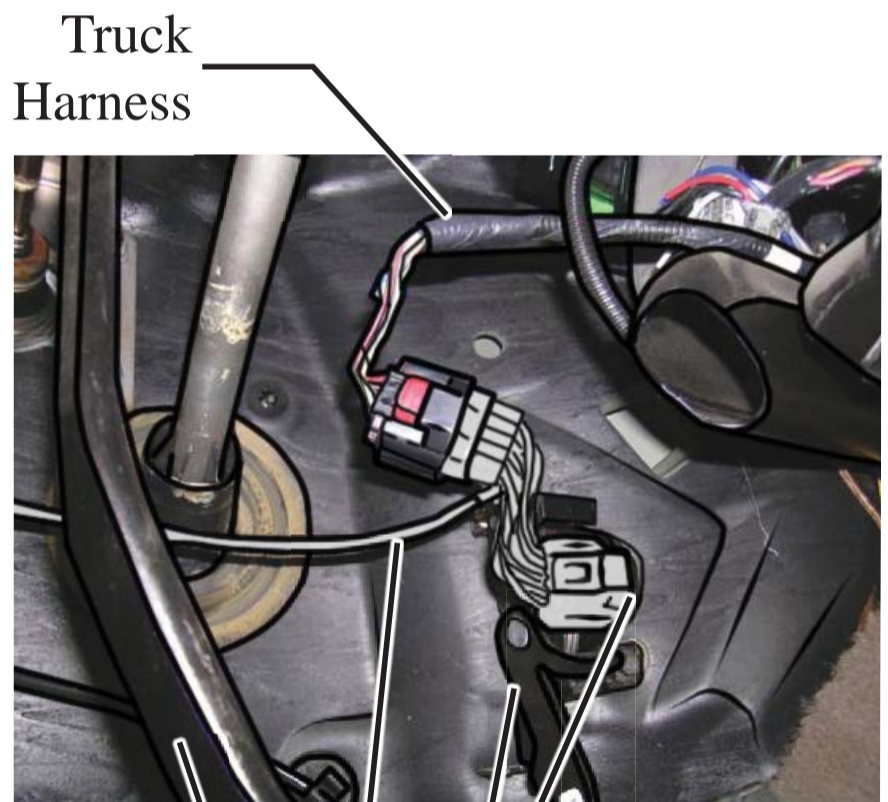

Brake Linkage
Edge TPS Adapter
TPS Sensor
Accelerator Linkage

FIGURE 12 - 2001-2003

(NOTE: The views in Figures 11 and 12 are showing underneath the dash console near the brake and accelerator pedals.)

3. Connect the TPS connectors in between the stock harness and the sensor as shown in Figure 13.

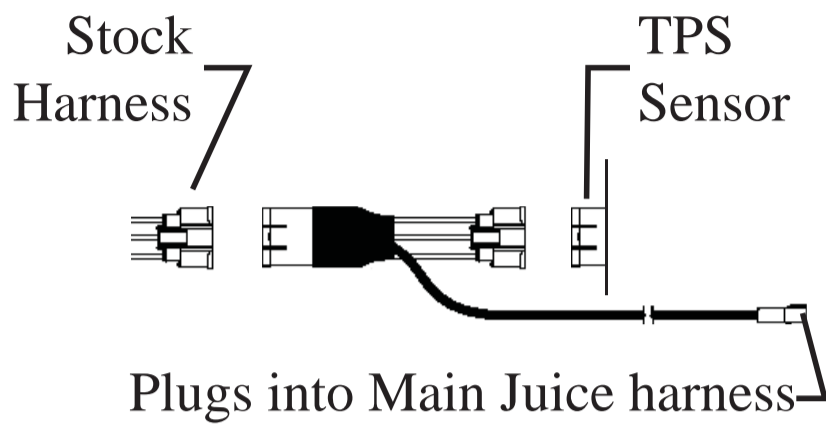

FIGURE 13 - "T" Assembly

4. From in the cab, route the TPS Sensor harness through the fire wall and into the engine compartment.

(NOTE: Route through the existing holes located on the fire wall.)

5. Locate the TPS Adapter wire as shown in Figure 1 on page 8.

6. Plug the single wire adapter into the end of the TPS Sensor harness.

This concludes the Juice Harness section of the installation. Please refer to the EGT PROBE INSTALLATION section of this manual to continue your installation.

2003 - 2007 (6.0L)

Supplied Items

- ① Main Harness
- ② Juice Module
- ③ Velcro Strips
- ④ Zip Ties
- ⑤ EGT Sensor Probe
- ⑥ Juice Attitude Bridge (JAB)
- ⑦ CS/CTS Installation Guide

Required Tools

- Electric/Cordless Drill
- 1/8" drill bit or similar size (for pilot hole)
- 21/64" (best size) or 5/16" drill bit (for final hole)
- 9/16" wrench or socket
- 5/8" open end wrench
- 1/8"-27 NPT Thread Tap
- Phillips screwdriver
- 5/16" or 8mm wrench
- 13mm wrench

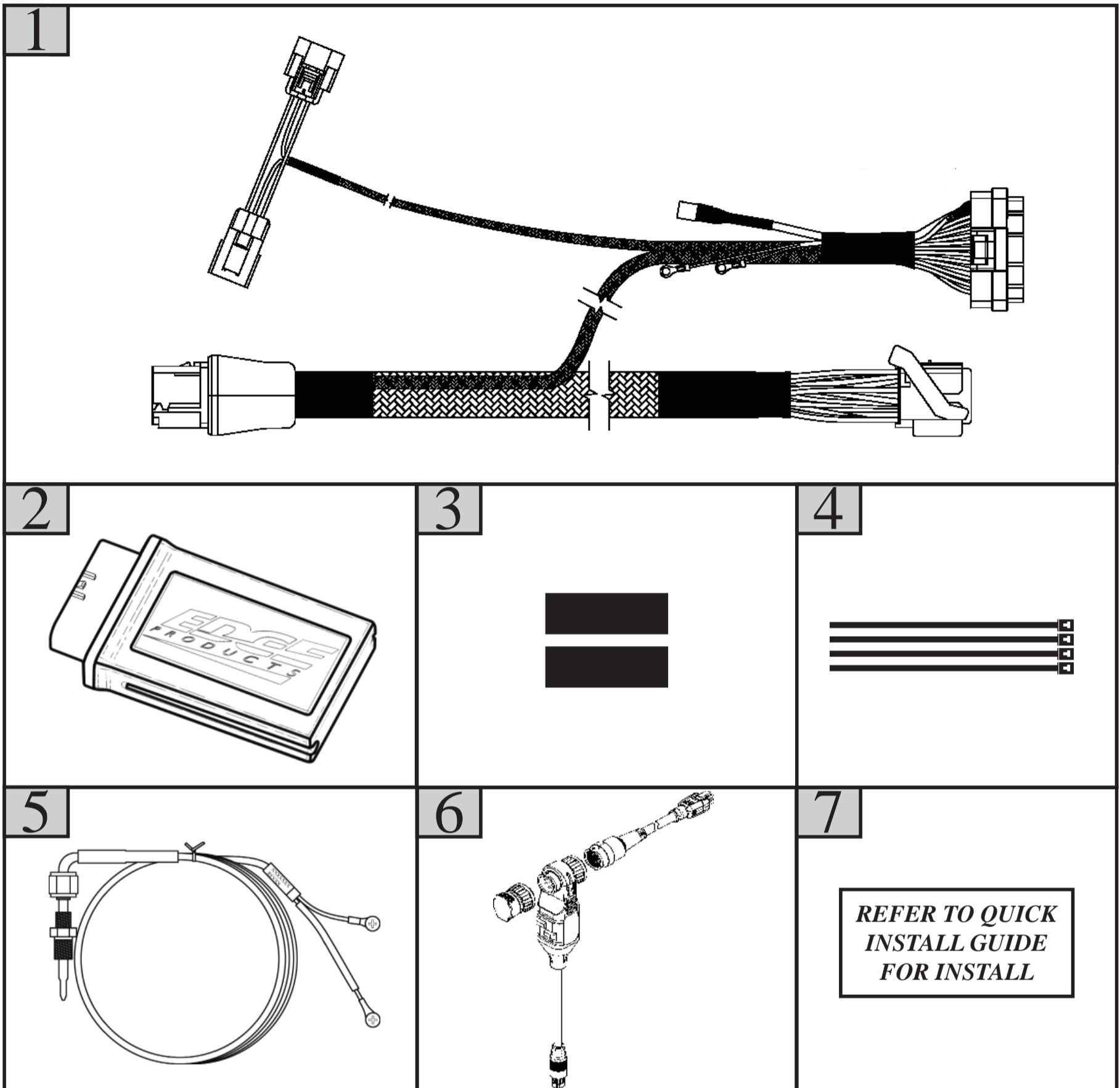

Note: Depending on your year of truck, you may not need everything provided.

Harness Connection Guide

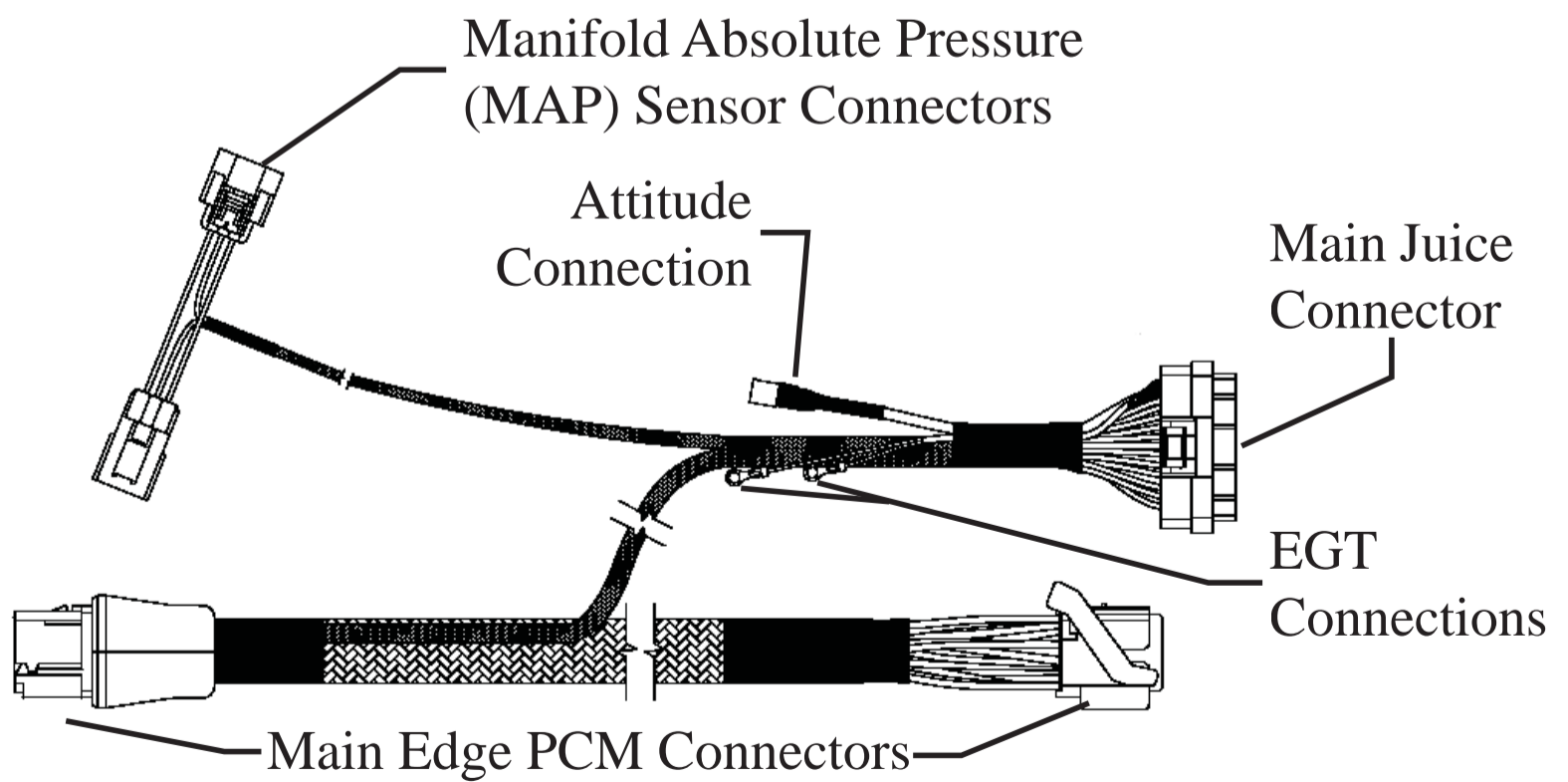

FIGURE 1

Juice Harness Installation Instructions

NOTE: Refer to the Engine Compartment section of this manual for general part locations under the hood.

BATTERY REMOVAL

WARNING An electrical charge or battery acid can burn you. Battery gas can explode or ignite. Take care when working around the battery. Follow instructions in the vehicle owner's manual for disconnecting and reconnecting a battery.

CAUTION: It is strongly recommended that both batteries be disconnected.

1. Remove the battery cables (negative first) using an 8 mm wrench.
2. Remove the driver side battery cover by releasing the tab located on the left side of the battery cover.
3. Completely remove the driver side battery and set aside. (This will allow you to easily connect the Main PCM connectors into to the PCM.)

PCM CONNECTIONS

1. Locate the PCM. It is shown below in Figure 2.

CAUTION: For connector removal, follow the instructions in step 3 to avoid damaging your engine harness or PCM connectors.

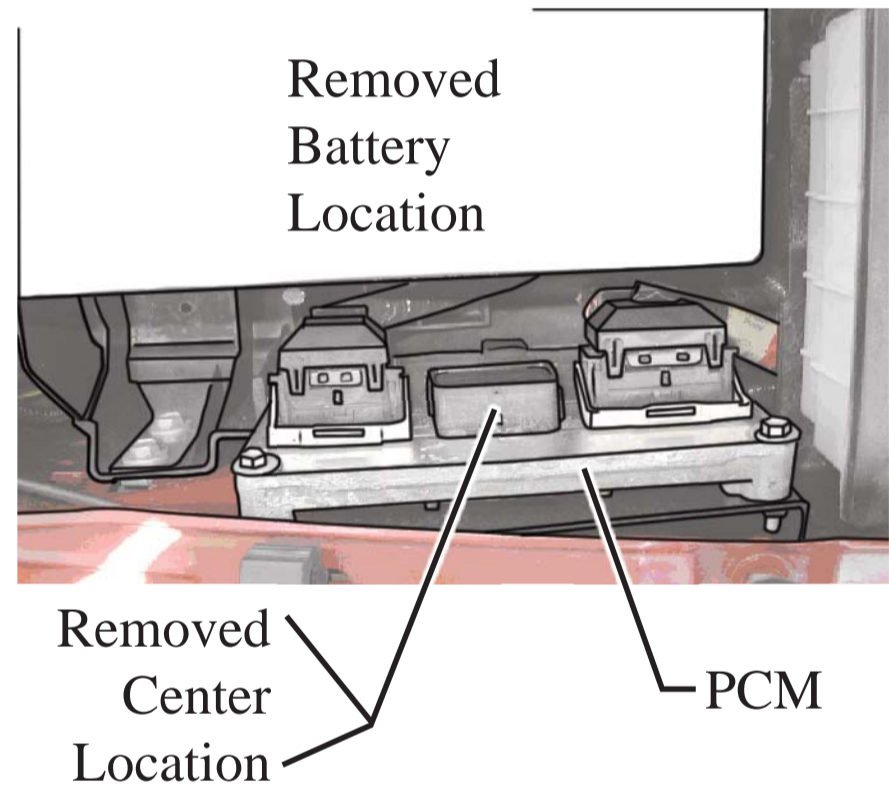

FIGURE 2 - PCM Location

2. Refer to Figure 3. In order to remove the engine harness from the PCM, the lever on the harness connector needs to be rotated away from the PCM. This will allow you to safely remove the harness.

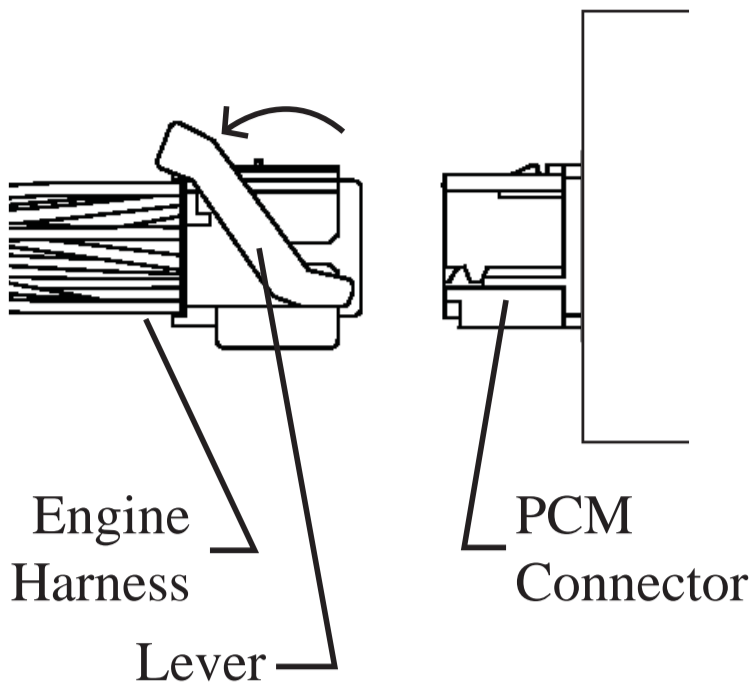

FIGURE 3 - Connector Removal

3. Disconnect the center harness as shown in Figure 2.
4. Connect the Main Edge PCM Harness as described in Figure 1 in between the PCM and Engine harness as described in Figure 4 below.

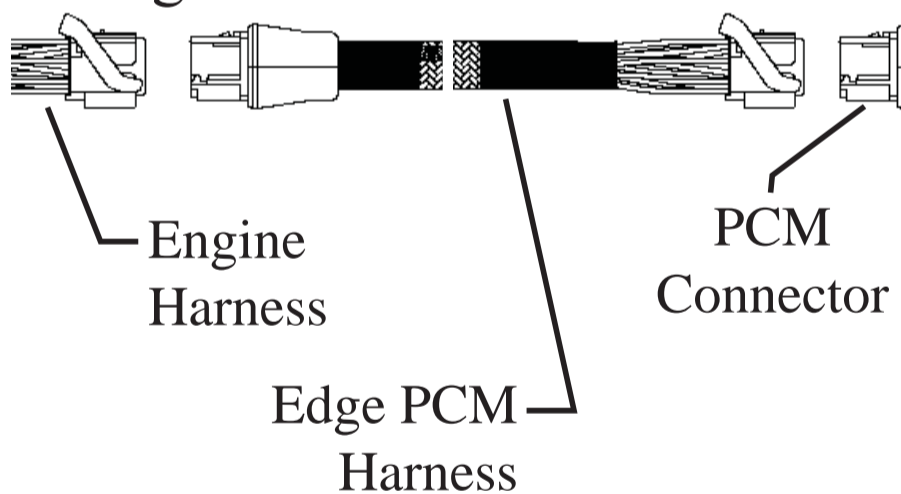

FIGURE 4 - PCM Installation

CAUTION: *The two connectors should slide easily together. DO NOT force the two connectors together. If the connectors do not slide smoothly, inspect for bent pins, and retry.*

CAUTION: *To keep water from causing damage to the engine and Juice harnesses, route the Juice harness as shown in Figure 5. This will also insure that the battery cover will fit back into place.*

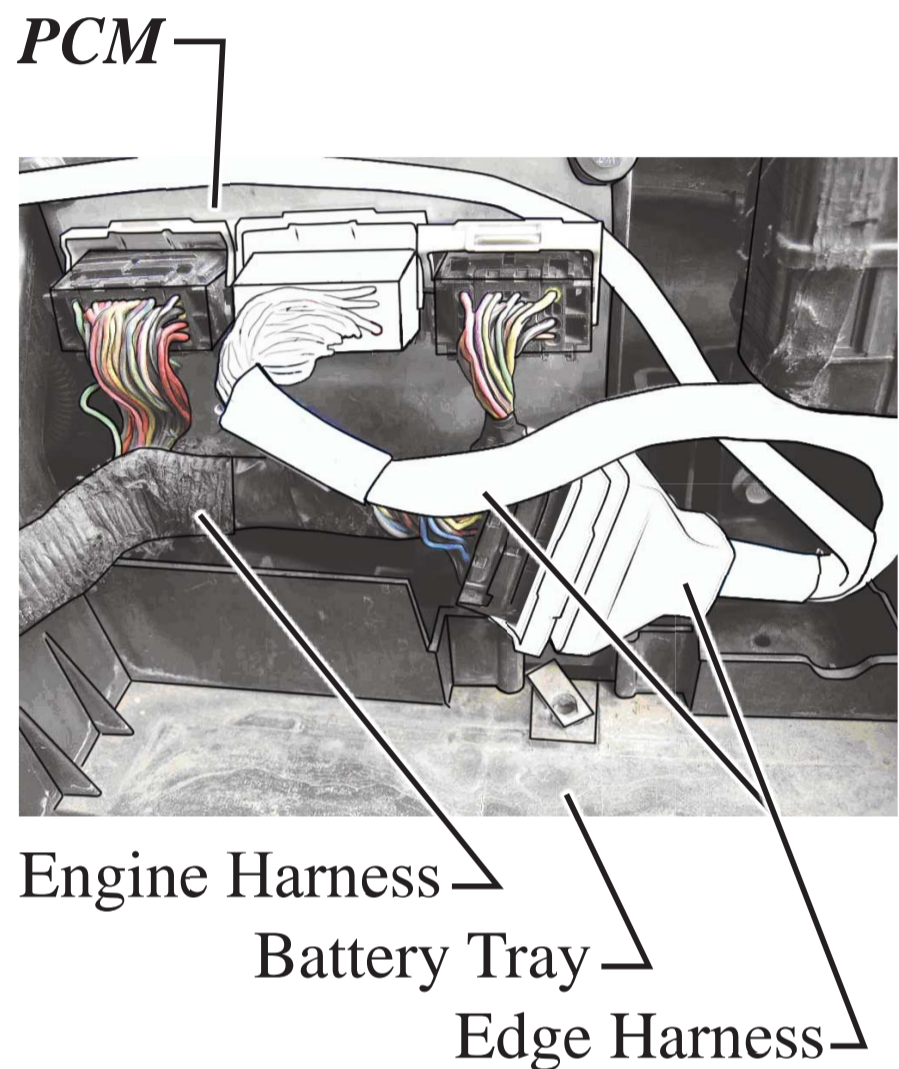

FIGURE 5 - Harness Routing

6. Replace the battery.
7. Reinstall battery cover.
8. Reconnect battery cables. (Positive first.)

MAP SENSOR CONNECTION

1. Using the Engine compartment section of this manual, locate the MAP Sensor.
2. Unplug the stock MAP harness, and insert the Edge MAP Sensor harness in between the

MAP harness and the sensor. Refer to Figure 6.

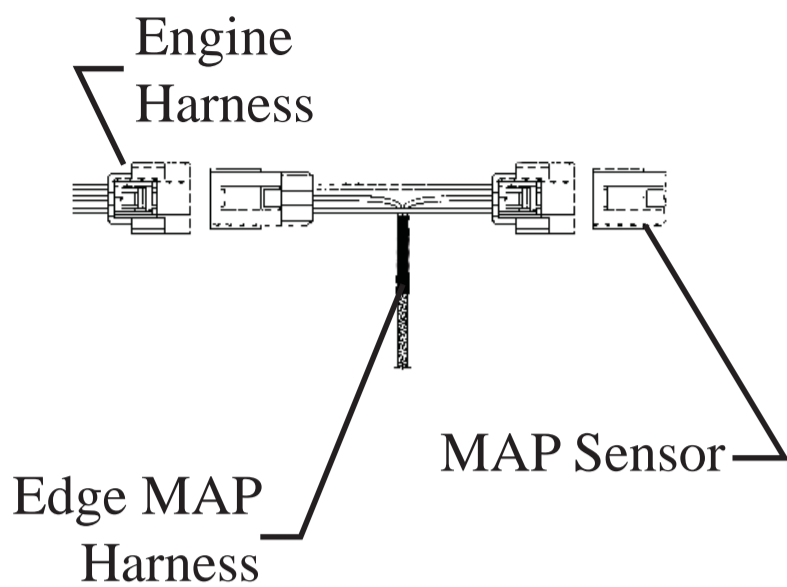

FIGURE 6 - "T" Assembly

3. Figure 7 shows an assembled MAP harness. Note that the MAP Sensor is bolted to the backside of the bracket shown.

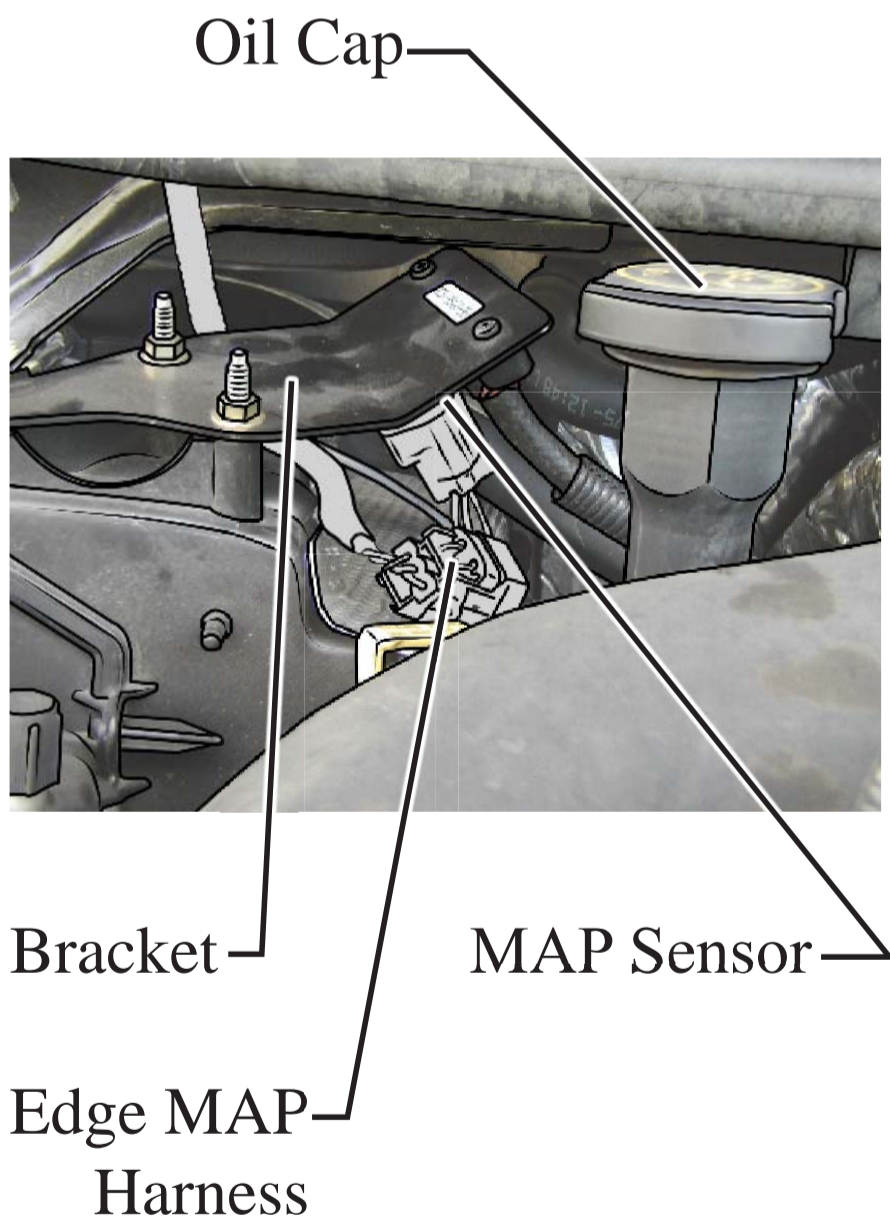

FIGURE 7 - Final Assembly

4. Use zip ties to fasten the harness. Keep all harness components away from hot engine surfaces, as well as moving parts.

This concludes the Juice Harness section of the installation. Please refer to the EGT PROBE INSTALLATION section of this manual to continue your installation.

EGT PROBE INSTALLATION

⚠ WARNING *When installing the EGT (Exhaust Gas Temperature) Thermocouple, wear eye protection and protective clothing to protect from getting metal chips in your eyes. Also, since exhaust manifolds can be very hot, allow the engine to cool before drilling. When working under the vehicle, make sure the park brake is set.*

Required Tools

- Electric/Cordless Drill
- 1/8" drill bit or similar size (for pilot hole)
- 21/64" (best size) or 5/16" drill bit (for final hole)
- 9/16" wrench or socket
- 5/8" open end wrench
- 1/8"-27 NPT Thread Tap
- Phillips screwdriver
- 5/16" or 8mm wrench

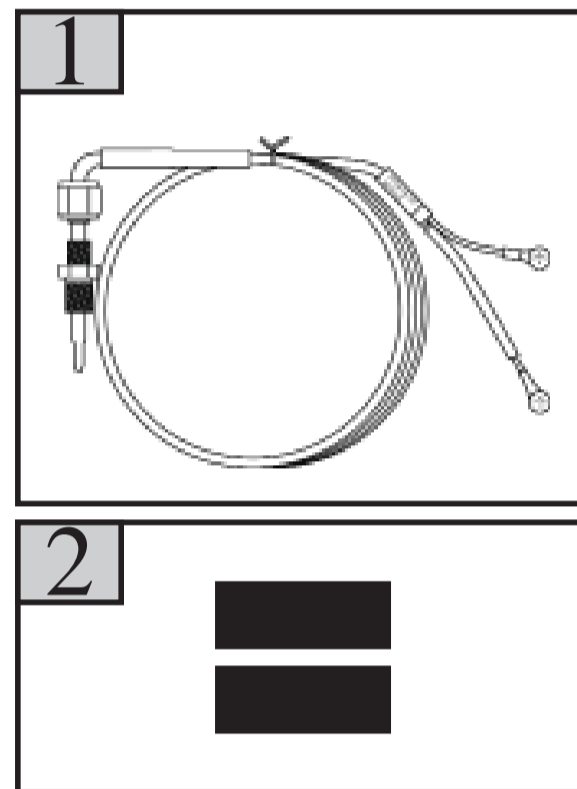

<u>Supplied Items</u>	<u>Qty</u>
① EGT Probe.....	(1)
2 Shrink Tube.....	(2)

CAUTION: *One effective way to avoid metal fragment contamination in your engine manifold is to apply grease in the tip of the drill bit and threads of your tap tool when drilling/tapping the hole in your manifold. Reduce pressure on the drill when the drill breaks through the manifold wall to reduce risk of pushing metal chips into the manifold.*

TAPPING AND PROBE INSTALLATION

1. Obtain a 1/8"-27 NPT Thread Tap available from your local hardware store.
2. Drill a 21/64" (5/16" optional) hole through the manifold wall.
3. Use the pipe tap to cut the threads in accordance to the pipe tap manufacturer's instructions and recommendations.
4. Remove the fitting from the Thermocouple and install by tight-

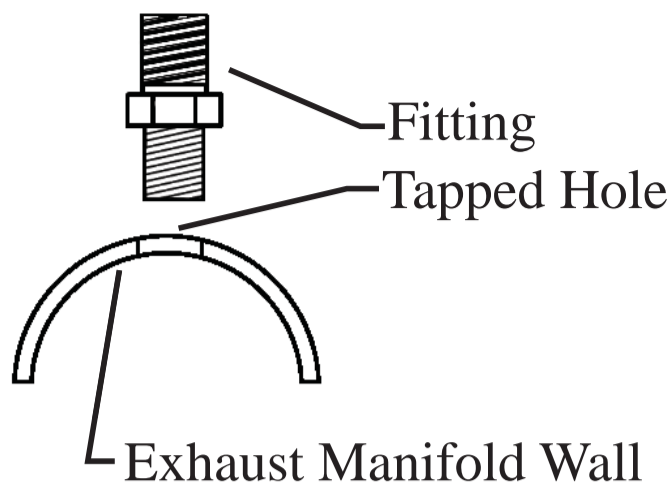

Figure 1 - Fitting Installation

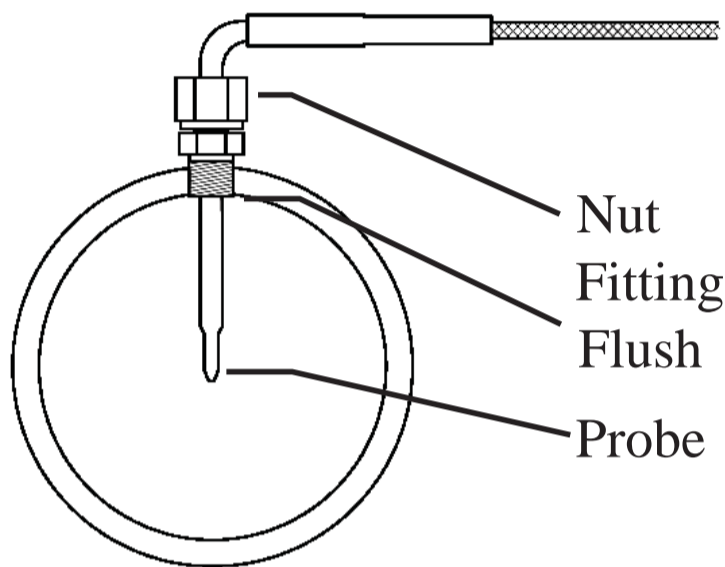

Figure 2 - Probe Insertion

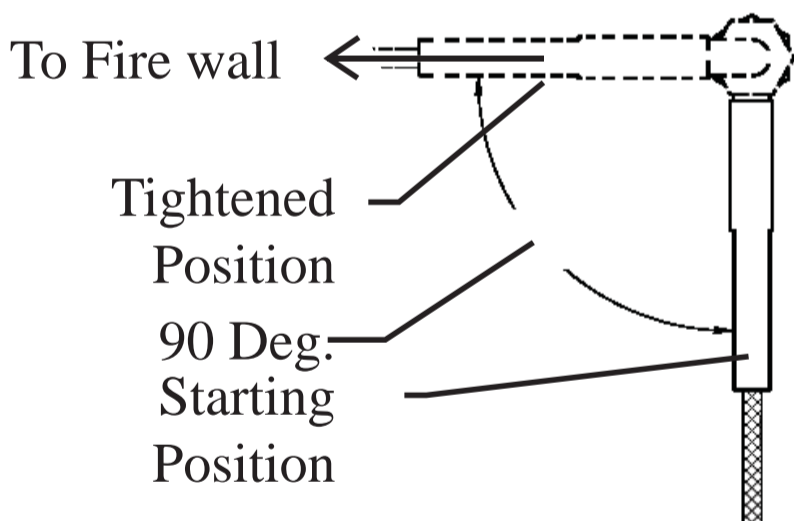

Figure 3 - 90 Degree

ening the tapered thread end into the manifold. (Figure 1)

5. Tighten the fitting so that it is securely seated.

6. Install the probe into the fitting, and tighten the top nut of the fitting just tight enough to keep the probe firmly mounted. (Figure 2)

NOTE: Ideally the tip of the fitting would be less than or flush with the inside of the exhaust flow path. (Figure 2)

7. Make sure that the probe cable is positioned to allow best path and minimal bending for routing to the fire wall.

NOTE: The probe will move approximately 90 Deg. clockwise in the direction the nut is tightened. Before fully tightening the nut, make sure the cable starts 90 Degrees from the final resting position. When tightened, the cable will be correctly positioned.

CAUTION: Do not bend the probe after installed. If needed, loosen the probe nut, adjust the probe, and re-tighten. Bending the probe tubing will result in a faulty probe.

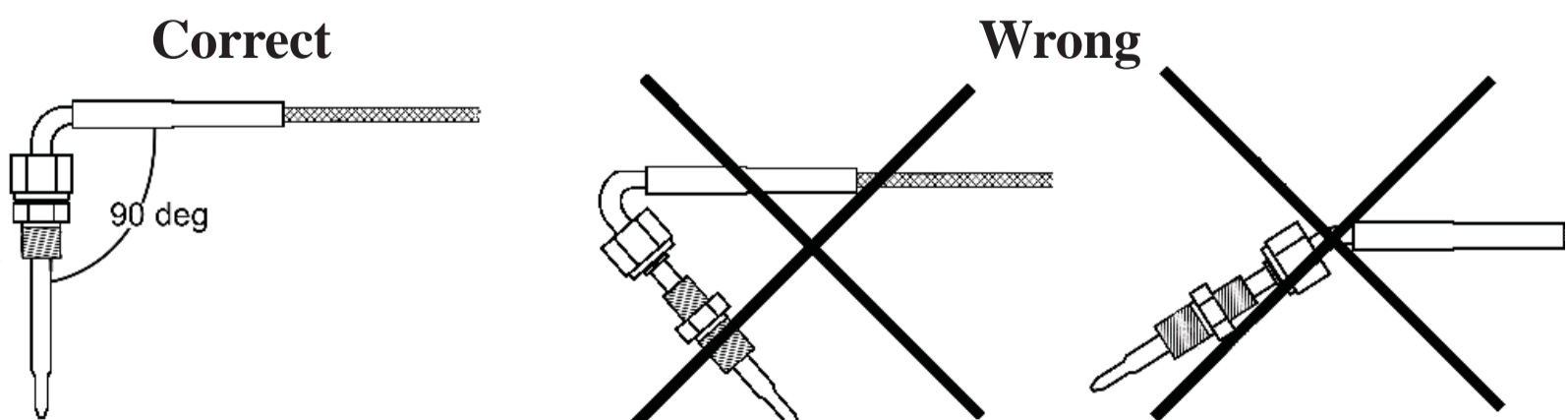
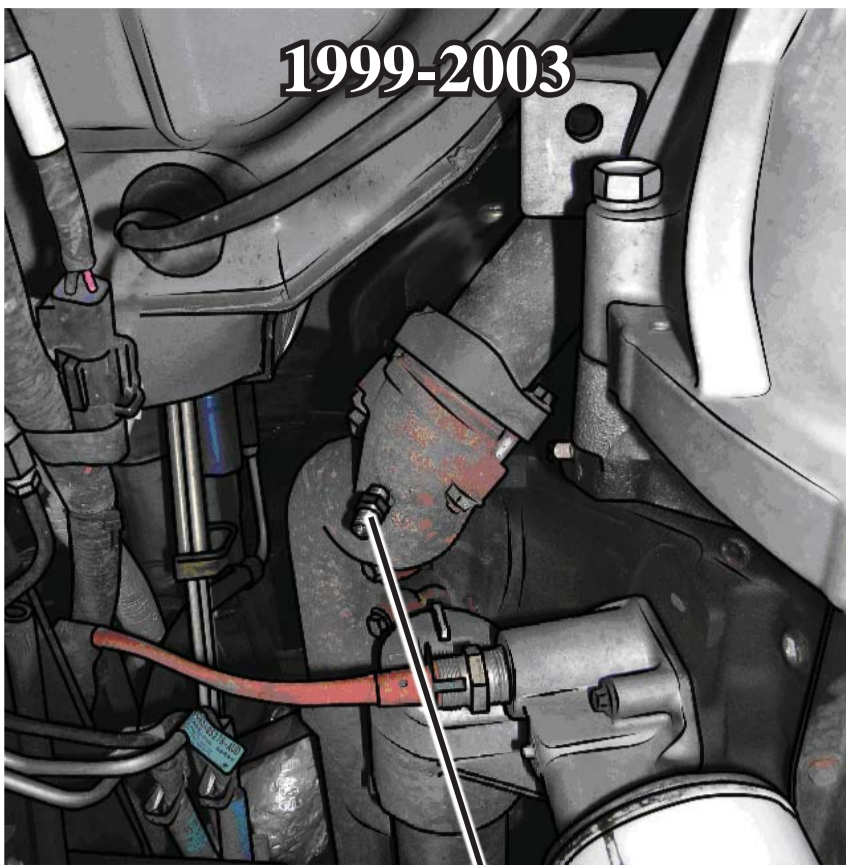
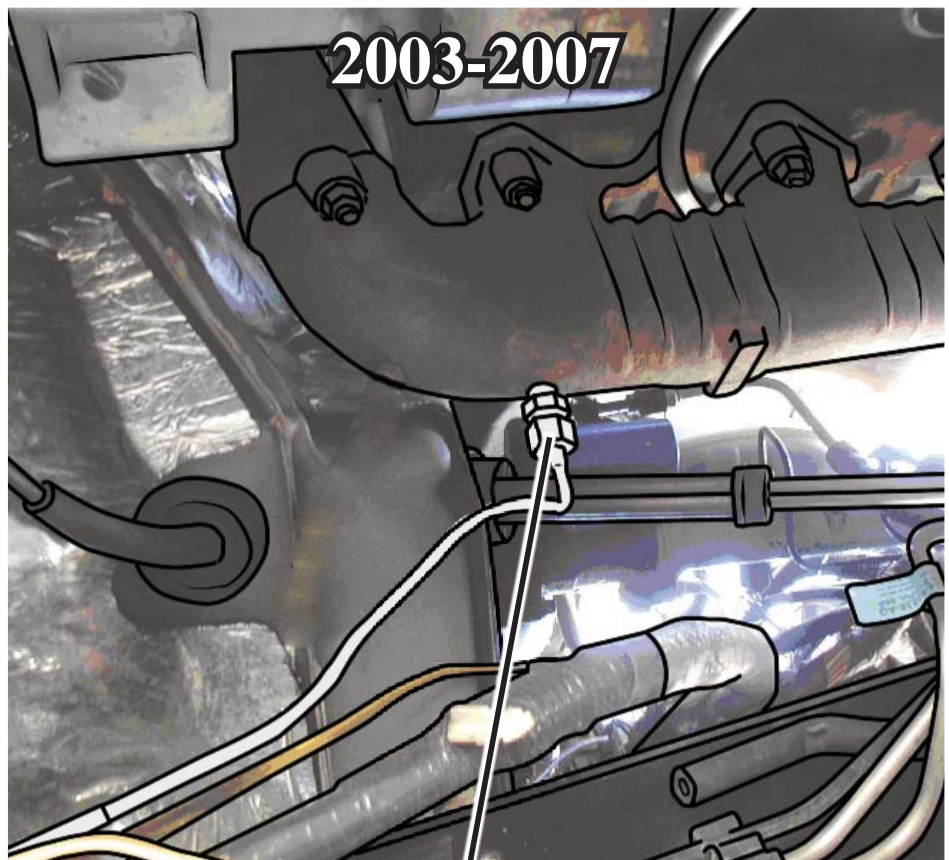

Figure 4 - DO NOT BEND



1999-2003



2003-2007

EGT Location per year range

NOTE: Find these exhaust manifold locations by laying on your back behind the driver side front tire and looking up. The 1999-2003 view shows only the fitting having been installed. The 2003-2007 view shows the Probe mounted to the fitting.

CONNECTING THE PROBE TO JUICE

1. Slide the shrink tube pieces over the two wires. Later you will slide them over the bolted connections. (Figure 5)

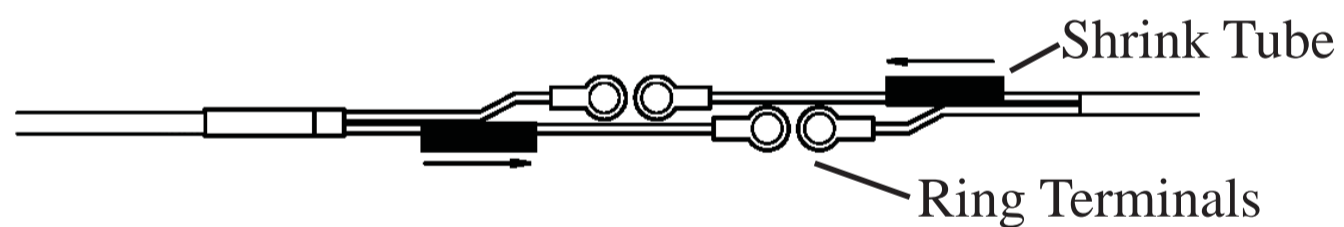

Figure 5 - Shrink Tube

2. Connect the (2) ring terminals to the mating Juice harness terminals using the supplied hardware. Yellow to Yellow. Red to Red. (Figure 6)

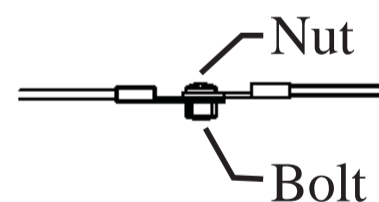

Figure 6 - Hardware Install

3. Tighten the nuts so that each wire is in line with its mating wire.
4. Position the supplied shrink tube over the secure fasteners.
5. Center the connection within the shrink tube. Heat and shrink

the tubing over the connections. (Figure 7)



Figure 7 - Shrink Tube Final

6. Secure the excess cable to the existing engine wire harnesses with supplied zip ties.

J A B I N S T A L L A T I O N

NOTE: The CS/CTS will not function unless the JAB is properly installed and plugged into both the Juice Module and Attitude Monitor (CS/CTS).

1999 to 2007 - JAB INSTALLATION

1. Locate the green connector on the Juice Harness and plug it into the Green connector on the JAB.

2. Under the hood, connect the 3 EAS components to one another. A “click” will be felt and heard indicating that the connectors are correctly fastened.

Figure 1 - Juice Harness

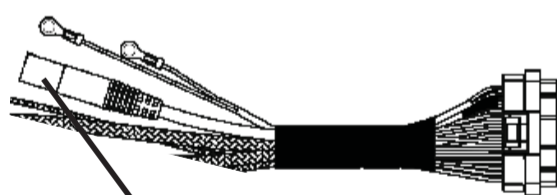

Green Connectors

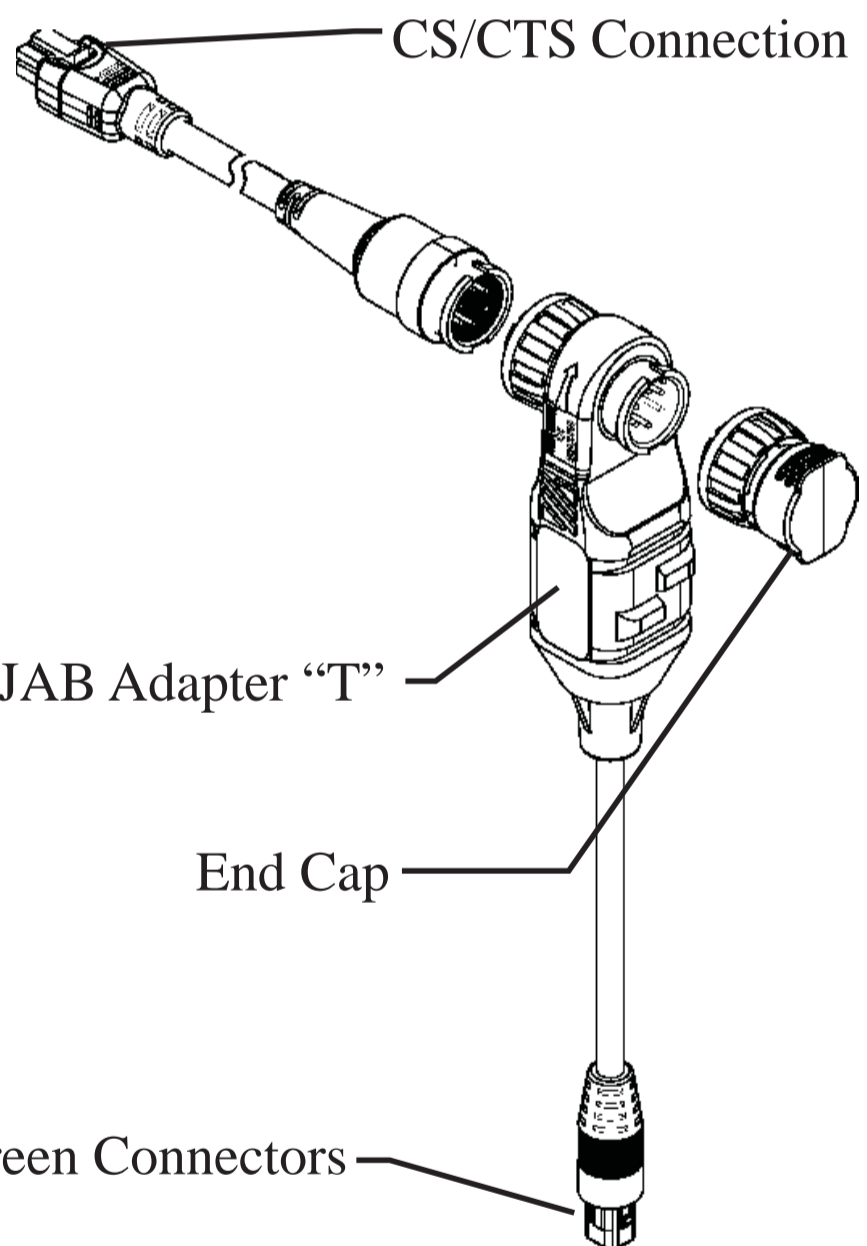

Figure 2 - JAB System

3. Route the CS/CTS Connector and cable through the fire wall grommet. The JAB and Juice Module will remain under the hood. (Figure 3)

TABLE OF CONTENTS

INTRODUCTION

INSTALLATION

OPERATING INSTRUCTIONS

APPENDIX

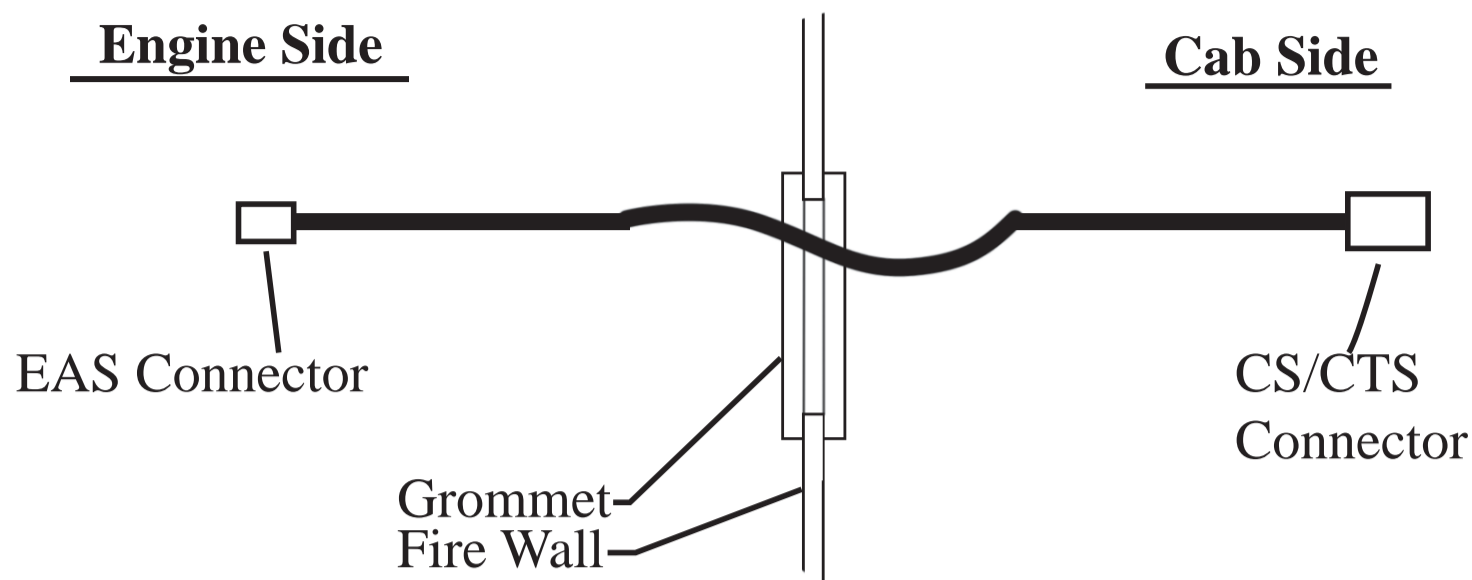

Figure 3 - Fire Wall Routing

4. Route the cable from below the dash up to the lower left corner of the driver side windshield. (Figure 4)

5. If needed, remove side panels to help see while routing.

6. Leave enough length between the dash and the end of the CS/CTS connector for easy CS/CTS install.

NOTE: For a clean look, the cable can be hidden behind the dash plastic and the door frame weather strip.

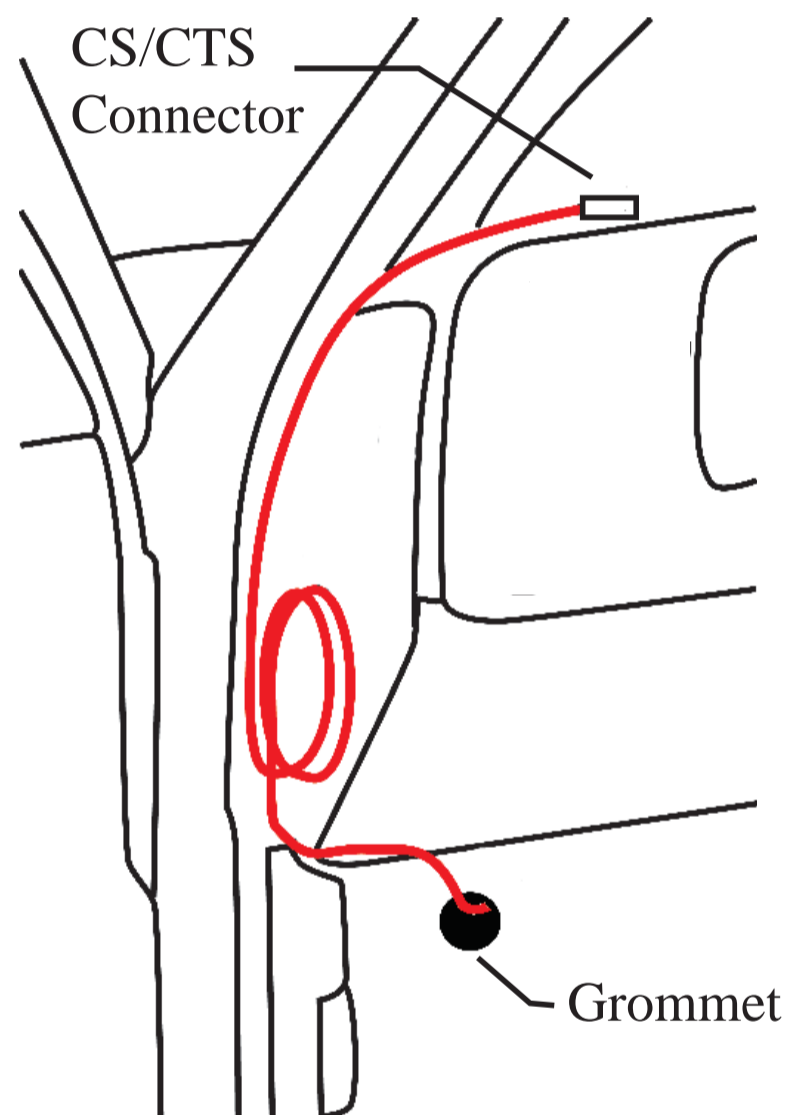

Figure 4 - In Cab Routing

7. Using the supplied zip ties, fasten the JAB connectors underneath the overhang which runs across the top of the fire wall. (Figure 5 - On next page)

8. Keep the JAB assembly close to the driver side.

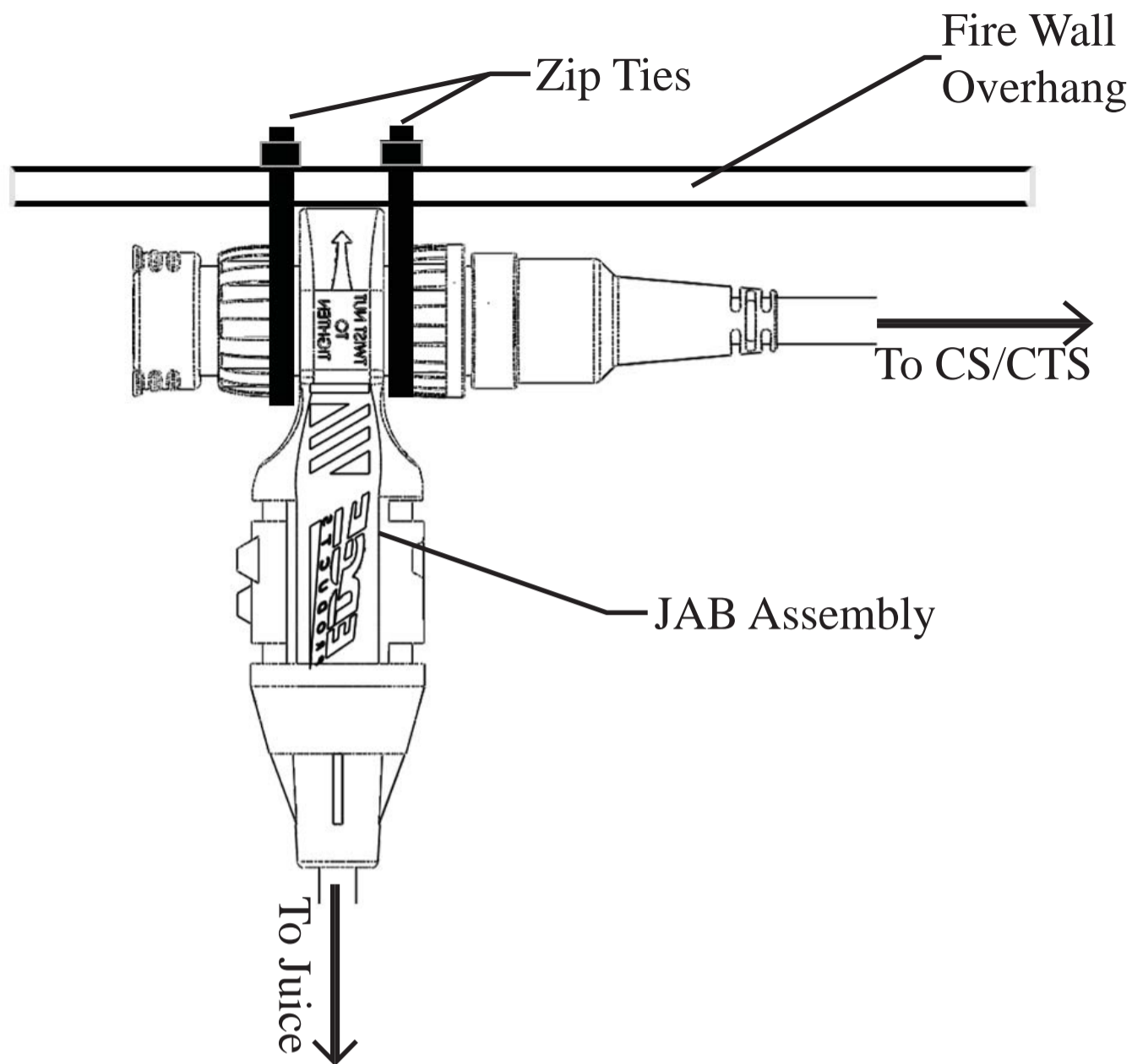

Figure 5 - Securing JAB
(Looking from the front of the truck to back)

JUICE MODULE INSTALLATION

FINAL JUICE MODULE INSTALLATION

1. Plug the “Main Juice Connector” into the “Juice Module” receptacle. (Figure 1)

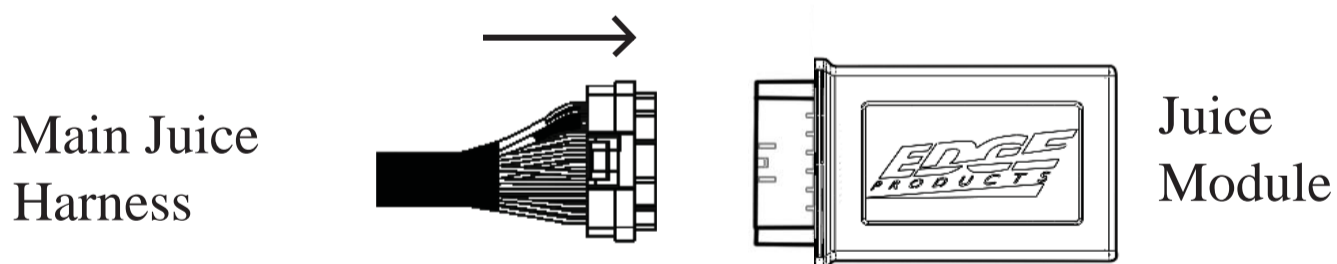

Figure 1 - Juice Module

MOUNTING AND SECURING THE JUICE

1. Attach one side of each Velcro strip to the back side of the Module and to the top side of a flat surface under the hood.

(NOTE: The best place is the top of the fuse box on the driver side. This will secure the Juice module and help keep it away from any moving or hot components under the hood.)

FINAL INSPECTION

1. Recheck all connections for a properly secure installation.
2. Using the supplied wire ties, secure the wiring harness and cable to prevent possible heat damage from hot engine surfaces. (For the 7.3L, pay special attention to the routing of the CMP harness as it is very close to moving parts.)
3. Reconnect the battery cables.
4. Start the engine. The engine should start and idle like a stock truck. If the engine does not start or run properly, turn off the engine. Remove the keys from the ignition, and check the Juice module connections. Make sure all connectors are fastened tightly.

If you continue to have problems, contact your dealer or Edge Products, LLC. **(888) 360-EDGE (3343)** 8:00 am - 5:00 pm MST

U S I N G T H E J U I C E**OPERATING THE ATTITUDE MODULE**

Refer to the CS/CTS User Manual for detailed descriptions on how to operate the Attitude Monitor.

ADDITIONAL JUICE/ATTITUDE INFORMATION**EGT's**

EGT stands for exhaust gas temperature, and is the single most important indicator of how a diesel engine is performing. Unlike a gasoline motor, a diesel motor will continue to make power as more fuel is added. As more fuel is added, the engine heat will also increase. Please be aware of the limitations of a stock engine.

ENGINE CODES

As with many aftermarket electronic performance modifications available for the Ford 7.3L Power Stroke® Diesel engine the Ford 7.3L Edge Products Juice module for the Ford 7.3 Power Stroke® Diesel engine will likely set engine “codes.”

The engine codes are generally set during heavy acceleration. Although the codes will remain “set” in the PCM, the dash board indicator light should turn off within 15 minutes. Most codes that are set under hard acceleration are called “soft codes”. These soft codes are retained in the PCM and can be erased by using the Edge Products CS/CTS to clear the codes.

Codes that may be set:

- P1211 – Injector control pressure is different than expected
- P1209 – Peak injection pressure fault

ENGINE COMPARTMENT (REFERENCE)

1999-2003

MAP Sensor MAT Sensor ICP Sensor



Suggested
Juice Module
Location

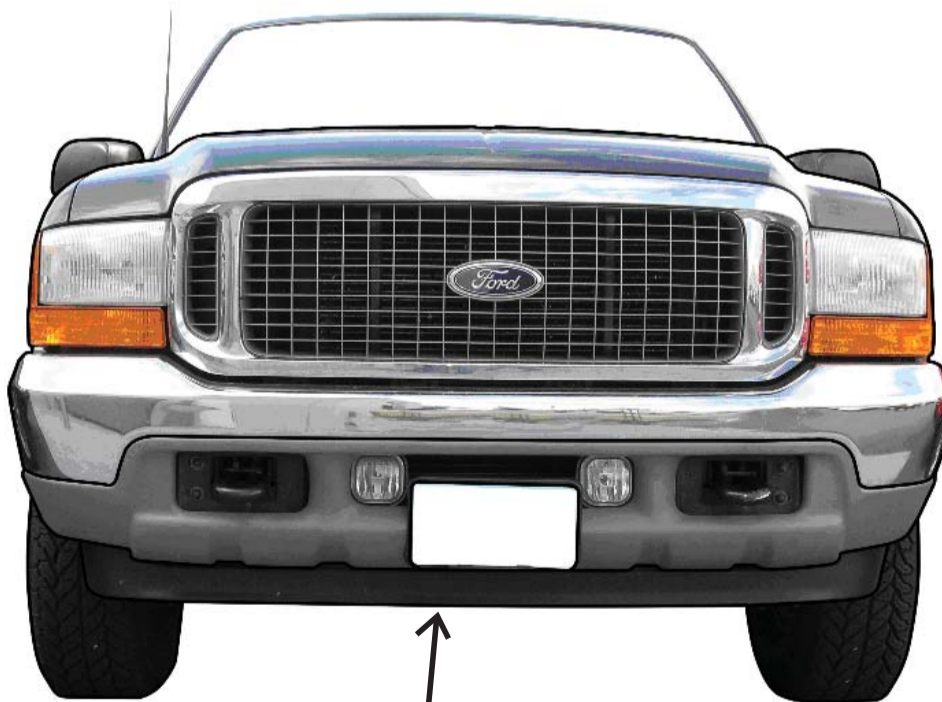

CMP
Sensor

2003-2007

TABLE OF CONTENTS
INTRODUCTION
INSTALLATION
OPERATING INSTRUCTIONS
APPENDIX

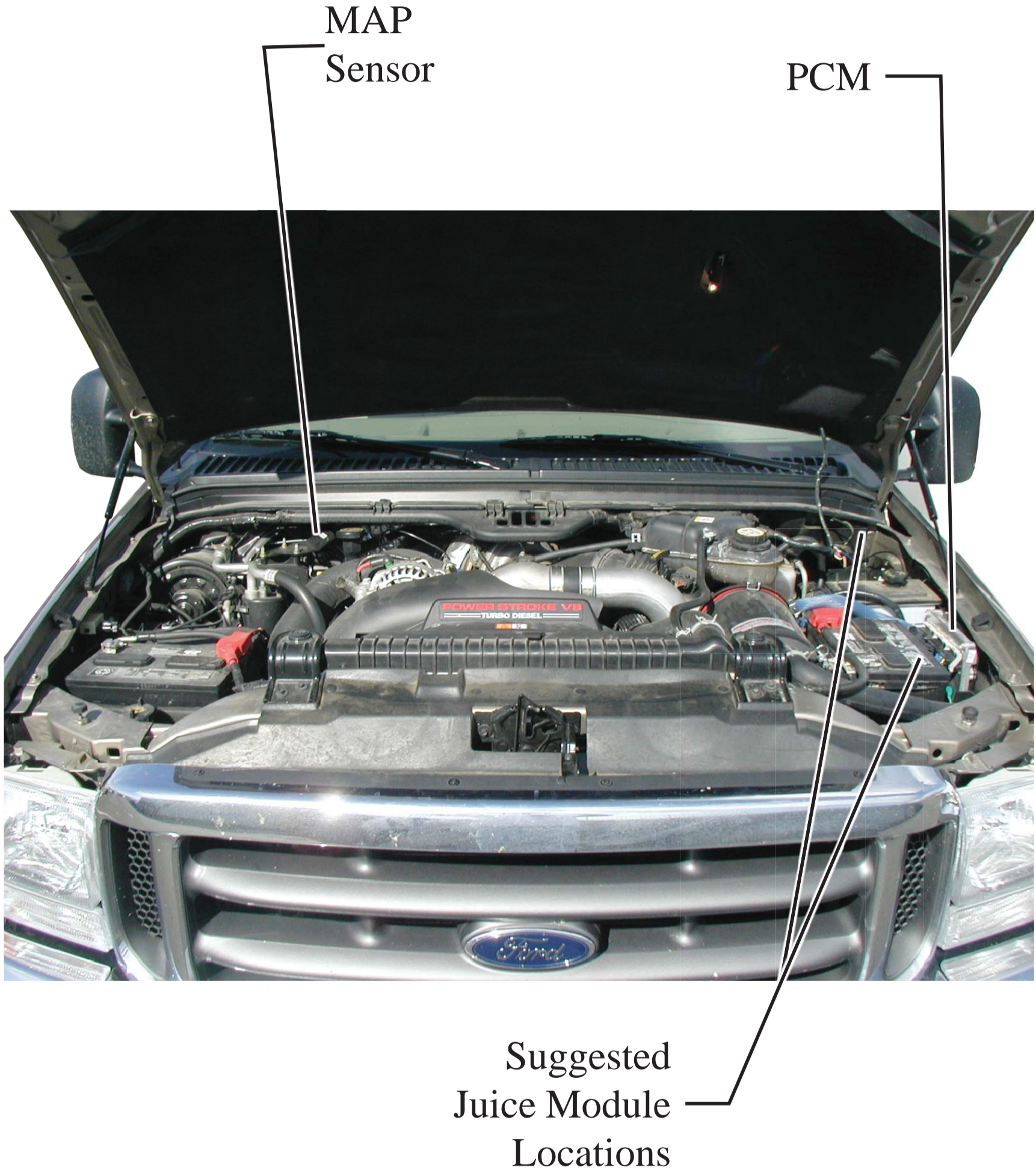

TABLE OF CONTENTS

INTRODUCTION

INSTALLATION

OPERATING INSTRUCTIONS

APPENDIX

COPYRIGHT © 2010 REV 00

For additional questions not found in the user guide call:

Edge Products Technical Support: (888) 360-EDGE (3343) 8:00 am - 5:00 pm MST

**To expedite your support call, please have your Vehicle Information,
Part Number, and Serial Number ready prior to calling Technical Support.**

**The Edge Products information is found on the label located
on the bottom of the device.**